

Find the area of each compound figure. Show how you break apart each figure. Include the units in your answer.

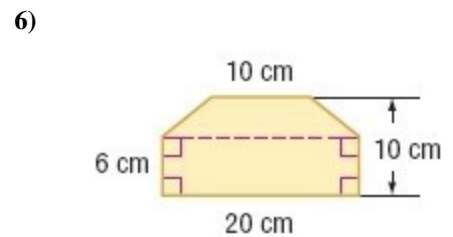

For #7 and #8, find the area of only the shaded region.

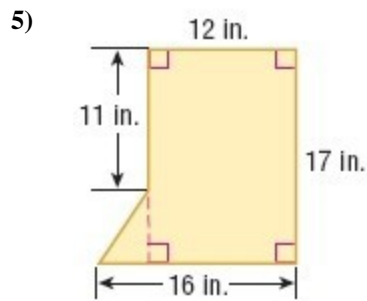
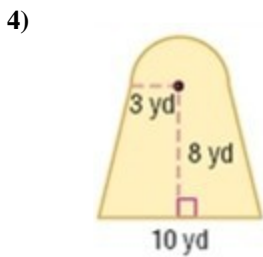
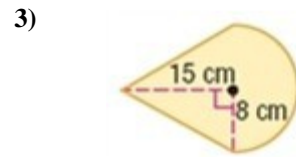
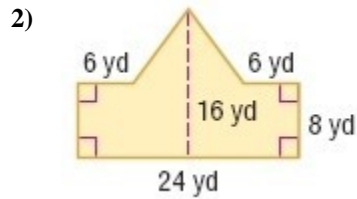
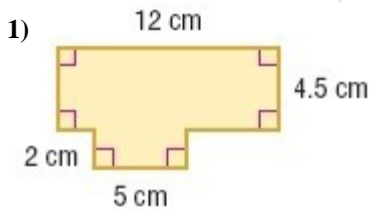
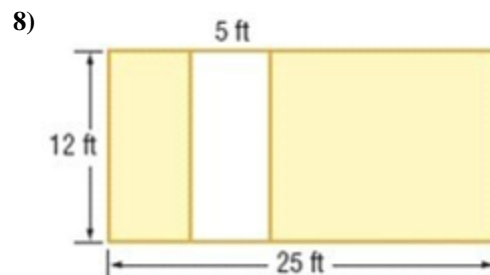
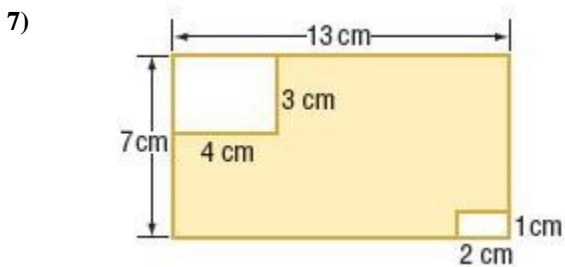

9) What is the total area of the figure shown?

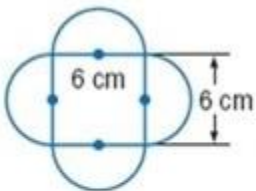

- A. 92.5 cm²
- B. 64.3 cm²
- C. 56.5 cm²
- D. 36.0 cm²